

LULU Single-lever bidet mixer with pop-up waste - Chrome

LULU

33 600 710



- 183mm projection
- ball-joint pivotable through 15° (in any direction)
- circular, air-enriched flow
- height of mixer 98 mm
- height up to aerator 63 mm
- hole diameter 35 mm
- 2x screw-in M 8 x 1 pressure hose, leak-tested
- max. flow 7 l/min
- WRAS 1804011



Chrome

33 600 710-00



Brushed Platinum

33 600 710-06

33 600 710

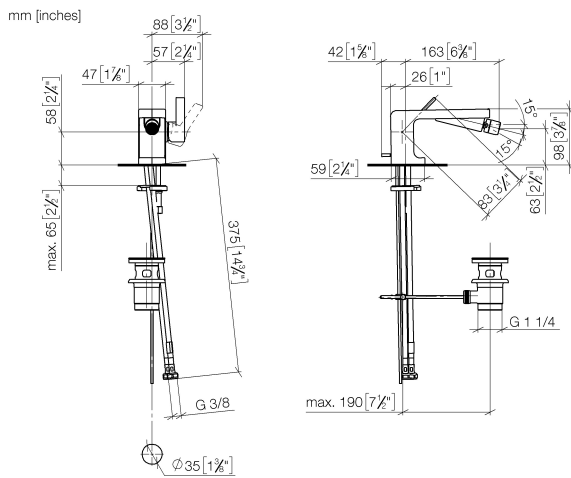

Flow rate chart



Certificates

WRAS_1804011. LGA_38146. WRAS_240202054.

33 600 710

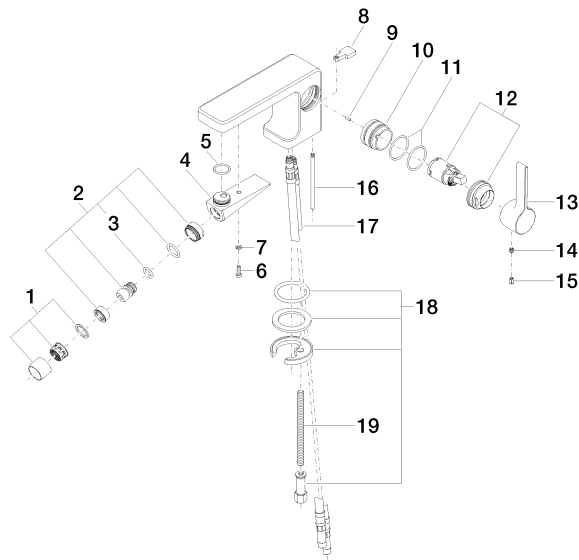

20 Abbildung 14.11.20.001.004

Spare parts list

No.	Item Number	Name	Quantity used	Delivery time
1	90 23 01 119 02-00	aerator	1	10
2	04 21 40 007 00-00	joint	1	10
3	90 14 10 011 00 90	seal	1	2
4	09 11 71 080-00	spout	1	60
5	90 14 10 010 00 90	seal	1	2
6	09 30 30 080 90	screw	1	2
7	90 30 11 029 00 90	disc	1	2
8	09 20 71 030-00	handle	1	10
9	09 31 11 111 90	pin	1	2
10	09 18 40 095 10 90	sleeve	1	2
11	09 14 10 137 90	seal	2	2
12	90 15 05 041 00-00	cartridge	1	2
13	09 20 71 040-00	handle	1	10
14	90 31 11 030 00 90	pin	1	2
15	09 31 20 017 90	plug	1	2
16	09 31 09 080-00	pull-rod	1	10
17	04 30 04 018 00 90	hose	2	60
18	04 30 11 038 75 90	fixing set	1	2
19	09 31 11 012 90	pin	1	2
20	90 11 01 001 00-00	pop-up waste	1	10